

## 1 General Information / Product Overview

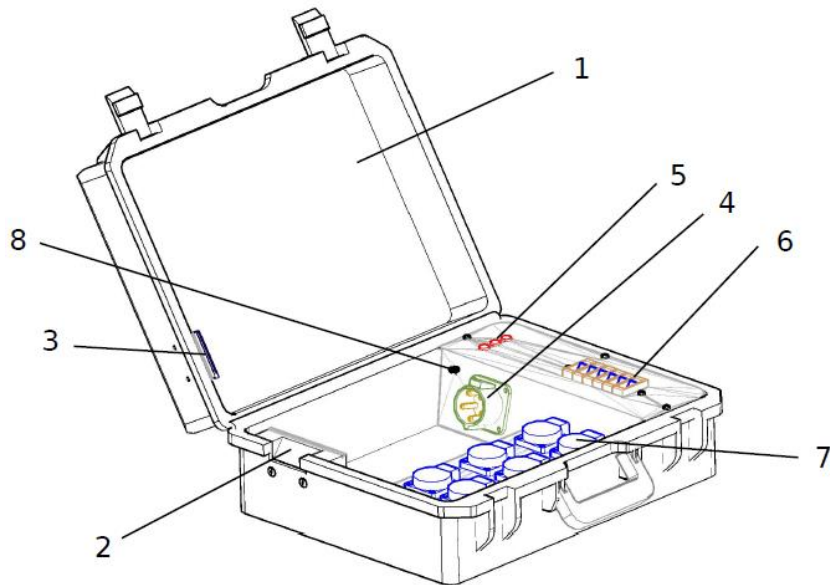













1. Case IP 44
2. Cable entry
3. Cover cable entry
4. Input: CEE Plug MENNEKES®, 400 V/32 A, 5 Pin
5. Phase indicator lights
6. 3x RCBO C16A (Residual Circuit Breaker with Overcurrent Protection)
7. Sockets: 6 x SCHUKO® MENNEKES®, 230 V/16 A
8. Ground

## 2 Technical Data

Power Supply	380-400 V AC, 50 Hz
Protection Rating	IP 44
Dimensions /LxWxH/	510x410x200 mm
Weight	7.5 kg

## 3 Application Notes

	<b>Storage during operation</b>					
	 	 	 	 	 	 

## 4 Safety Information

	<b>Required Installation skills</b>
	<p>Installation only by persons with relevant electrotechnical knowledge and experience!</p> <p><b>Contact your professional electrical contractor!</b></p>



**SENCI**  
Nijverheidsweg 20  
7671 DA Vriezenveen  
Nedetherlands  
Tel: +31 (0)85 303 65 97  
Mail: [info@senci.nl](mailto:info@senci.nl)  
Website: [www.senci.nl](http://www.senci.nl)

---

**GLP German Light Products GmbH**  
Industriestr. 2, 76307 Karlsbad, Germany  
Tel: +49 (0)72 48 / 927 19 - 0, Fax: -30,  
E-Mail: [info@glp.de](mailto:info@glp.de), Internet: [www.glp.de](http://www.glp.de)

# Product Description

**PDS-32/s**  
Power Distribution Case RCBO



Version 1.1

